

## Kinetic Modeling of Heavy Metals Adsorption on fixed bed Column

Nwabanne, J. T.\* and Igbokwe, P. K.

Department of Chemical Engineering, Nnamdi Azikiwe University, P.M.B. 5025, Awka, Nigeria

Received 27 Sep. 2011;

Revised 2 May 2012;

Accepted 20 May 2012

**ABSTRACT:** The adsorption of lead (II) and copper (II) in a fixed bed column using activated carbon prepared from nipa palm nut was investigated. Thomas model and Yoon and Nelson kinetic models were used to analyze the column performance. The rate constant for Thomas model increased with increase in flow rate and initial ion concentration but remained constant at varying bed height. Adsorption capacity for the adsorption of copper (II) obtained from Thomas model ranged from 3.417 to 17.224 mg/l for Thomas model and from 3.02 to 11.92 mg/l for Yoon and Nelson model. Also the adsorption capacity for lead (II) adsorption calculated from Thomas model ranged from 6.937 to 75.59 mg/l and from 12.10 to 47.24 mg/l for Yoon and Nelson model. The maximum adsorption capacity increased with increase in flow rate and initial ion concentration but decreased with increase in bed height. For Yoon and Nelson model, the rate constant increased with increase in flow rate, initial ion concentration and bed height. The time required for 50% breakthrough decreased with increase in flow rate, bed height and initial ion concentration. The kinetic data fitted well to both models. The comparison of the experimental breakthrough curves to the breakthrough profiles calculated by Yoon and Nelson method showed a satisfactory fit for activated carbon prepared from nipa palm nut.

**Key words:** Kinetics, modeling, Adsorption, heavy metals, fixed bed column

### INTRODUCTION

With the rapid development of chemical and petroleum processing industries in Nigeria, there is an increase in the amount and the variety of chemicals that are discharged into waters. Wastewater from various industries and municipal corporations are discharged into ground and surface water, making it unfit for human and animal consumption. Some of the organic and inorganic compounds, when present in water, are toxic, carcinogenic, and mutagenic, and they cause several ailments in humans (Roque-Malherbe, 2007, Bansal and Goyal, 2005). Heavy metal ions are described as priority pollutants, due to their mobility in natural water ecosystems and due to their toxicity (Volesky and Holan, 1995; Nasrabadi *et al.*, 2010; Haruna *et al.*, 2011; Serbaji *et al.*, 2012; Ogundiran *et al.*, 2012; Yu *et al.*, 2011; Kargar *et al.*, 2012; Mzoughi and Chouba, 2012; Ghaderi *et al.*, 2012). These heavy metals are not biodegradable and their presence in waters leads to bioaccumulation in living organisms causing health problems in animals, plants, and human beings (Ong *et al.*, 2007; Alimohammad Kalhori *et al.*, 2012; Ashraf *et al.*, 2012; Okuku and Peter, 2012; Mhadhbi *et al.*, 2012; Divis *et al.*, 2012). Lead is a pollutant that is present in

drinking water and in air. Lead is known to cause mental retardations, reduces haemoglobin production necessary for oxygen transport and it interferes with normal cellular metabolism (Qaiser *et al.*, 2007). Copper is metal that has a wide range of applications due to its good properties. It is used in electronics, for production of wires, sheets, tubes, and also to form alloys (Antonijevic and Petrovic, 2008). Adsorption onto activated carbon has been found to be better than other methods of wastewater treatment because of its capability for adsorbing a broad range of different types of adsorbates efficiently, and its simplicity of design (Ahmad *et al.*, 2006; Markovska *et al.*, 2006). Many researchers have studied cheaper substitutes, which are relatively inexpensive, and are at the same time endowed with reasonable adsorptive capacity. These studies include the use of coal (Mohan *et al.*, 2002), fly ash (Mohan *et al.*, 2002; Nollet *et al.*, 2003; Gupta *et al.*, 2003; Ricou *et al.*, 2001, Gupta and Ali, 2004), etc. The study of sorption kinetics in wastewater treatment is important since it provides valuable insights into the reaction pathways and mechanism of adsorption process (Mincera *et al.*, 2008; Maximova and Koumanova, 2008). In order to examine

\*Corresponding author E-mail: joe\_nwabanne@yahoo.com

the mechanism of adsorption process, a suitable kinetic model is needed to analyse the rate data (Ozacar, 2003). Two models (Thomas model and Yoon and Nelson model) were used to analyze the column performance for the removal of lead (II) and copper (II) from aqueous solution using activated carbon prepared from nipa palm nut (NPN). The Thomas model is also referred to as the bed-depth-service-time (BDST) model (Kavak and Öztürk, 2004). Yoon and Nelson model is based on the assumption that the rate of decrease in the probability of adsorption for each adsorbate molecule is proportional to the probability of adsorbate adsorption and the probability of adsorbate breakthrough on the adsorbent (Kavak and Öztürk, 2004). This work provides data for the design of wastewater and water treatment equipment.

## MATERIALS & METHOD

Nipa palm nuts were obtained from Nkpogu village, Rivers state, Nigeria. The palm nuts were washed with deionized water, dried in the sun, ground into fine particles and sieved to a particle size of 300 $\mu$ m. 200g of sample was impregnated with concentrated orthophosphoric acid at the acid/precursor ratio of 2:1 (wt basis). The impregnated sample was dried in an oven at 120°C for 24hrs. The dried sample was carbonized in a Muffle furnace for 1hr at 500°C. After cooling to the ambient temperature, the sample was washed with de-ionized water several times until pH 6-7, filtered with Whatman No.1 filter paper and then dried in the oven at 110°C for 8hours. The sample was crushed and passed through different sieve sizes and then stored in a tight bottle ready for use.

The pH of the carbon was determined using standard test of ASTM D 3838-80 (ASTM, 1996). Moisture content of activated carbon and raw materials was determined using ASTM D 2867-91 (1991). The bulk density of the activated carbon was determined according to the tamping procedure by Ahmedna et al (1997). The volatile content was determined by weighing 1.0g of sample and placing it in a partially closed crucible of known weight. It was then heated in a muffle furnace at 900°C for 10mins. The percentage fixed carbon was determined as 100 – (Moisture content + ash content + volatile matter). The iodine number was determined based on ASTM D 4607-86 (1986) by using the sodium thiosulphate volumetric method. The specific surface area of the activated carbon was estimated using Sear's method (Al-Qadah and Shawabkah, 2009 and Alzaydien, 2009) by agitating 1.5g of the activated carbon samples in 100ml of diluted hydrochloric acid at a pH = 3. Then a 30g of sodium chloride was added while stirring the suspension and then the volume was made up to 150ml with deionized

water. The solution was titrated with 0.1N NaOH to raise the pH from 4 to 9 and the volume, V recorded. The surface area according to this method was calculated as  $S = 32V - 25$ . Where, S = surface area of the activated carbon, V = volume of sodium hydroxide required to raise the pH of the sample from 4 to 9.

The chemicals used were lead nitrate salt (Pb(NO<sub>3</sub>)<sub>2</sub>), copper sulphate (CuSO<sub>4</sub>) and de-ionized water. The reagents were of high grade. The samples (Pb(NO<sub>3</sub>)<sub>2</sub> and (CuSO<sub>4</sub>) were dried in an oven for 2hrs at 105°C to remove moisture. The adsorbates were produced by dissolving 1.6g and 2.51g of Pb(NO<sub>3</sub>)<sub>2</sub> and CuSO<sub>4</sub> respectively in 1000ml of de-ionized water separately to get the stock solution of 1000g/L.

A glass adsorption column of 30mm internal diameter and length of 300mm was used to perform fixed bed column studies. The granulated activated carbon having 0.425mm to 0.600mm particle size range was used. The activated carbon was packed in the column with a layer of glass wool at the bottom. Bed height of 50mm, 100mm and 150mm was used. The metal solution was introduced into the column by gravitational flow. The first tank delivers the solution to the second tank at a constant flow rate. The second tank is equipped with a pipe to help maintain a constant solution level in the tank in order to maintain a constant flow rate of the solution being delivered to the column. The second flow controller was used to regulate the flow rate. Three flow rates (5, 7.5 and 10ml/min) were used with initial ion concentrations of 50, 100 and 150mg/l. The adsorption study was performed at 30°C and pH of 6 and 7 for lead (II) and copper (II) respectively. The effluent samples were collected at specified intervals and analyzed for the residual ion concentration using atomic adsorption spectrophotometer at 217nm for Pb<sup>2+</sup> and 324.8nm for Cu<sup>2+</sup>. Column studies were terminated when the column reached exhaustion. The schematic diagram of the mini adsorption column used is shown in Fig. 1.

## RESULTS & DISCUSSION

### Characteristics of activated carbon derived from nipa palm nut

The physico-chemical characteristics of activated carbon are shown in Table 1.

Thomas model and Yoon and Nelson kinetic models were used to analyze the column performance. Thomas model has been used by many researchers to study packed bed adsorption kinetics (Kavak and Öztürk, 2004; Baek et al., 2007 and Sivakumar and Palanisamy, 2009). The linearized form of the Thomas model is described by equation (1) (Kavak and Öztürk, 2004).

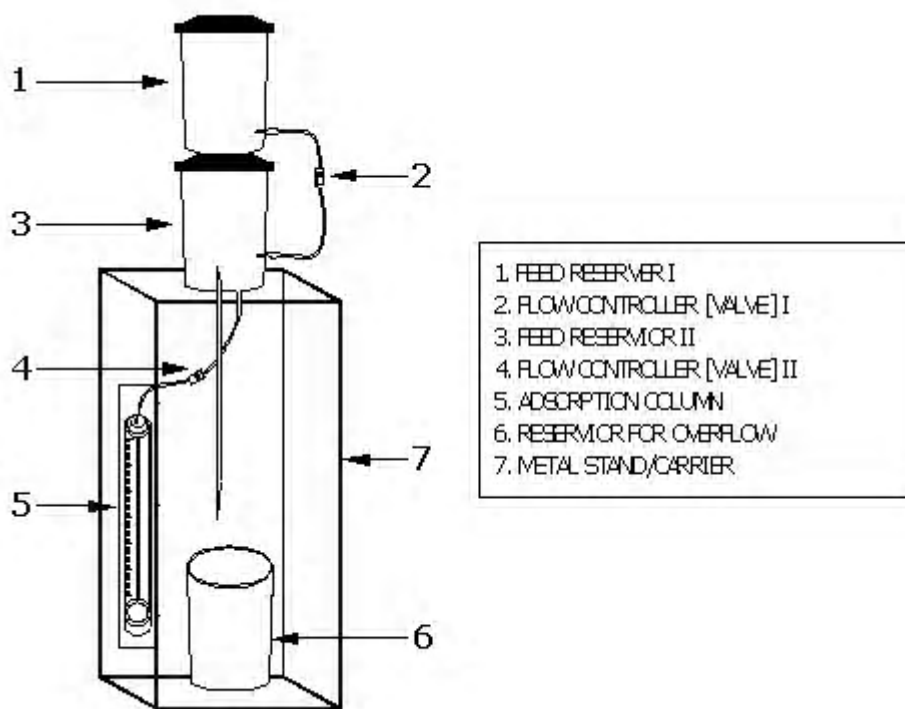

**Table 1. The physico-chemical characteristics of activated carbon prepared from NPN**

Properties	Values
pH	6.9
Bulk density, g/cm <sup>3</sup>	0.53
Iodine number, mg/g	815.62
Moisture content, %	4.80
Volatile matter, %	24.60
Ash content, %	3.88
Fixed carbon, %	71.52
Surface Area, m <sup>2</sup> /g	871.22

$$\ln\left(\frac{C_o}{C_e} - 1\right) = \frac{K_T q_o M}{Q} - \frac{K_T C_o}{Q} V \quad (1)$$

Where  $C_e$ ,  $C_o$  = the effluent and inlet solute concentrations (mg/l),  $q_o$  = the maximum adsorption capacity (mg/g),  $M$  = the total mass of the adsorbent (g),  $Q$  = volumetric flow rate (ml/min),  $V$  = the throughput volume (ml) and  $K_T$  = the Thomas rate constant (ml/min/mg). The kinetic coefficient,  $K_T$  and the adsorption capacity of the bed,  $q_o$  were determined from the plot of  $\ln [(C_o/C_e)-1]$  against  $V$  at a given flow rate (Figs 2, 3, 4, 5, 6, 7). The results of  $K_T$ ,  $R^2$  and  $q_o$  are given in Tables 2 and 3. The values of  $K_T$  obtained in this work are similar to the ones obtained by Sivakumar and Palanisamy (2009). High values of regression coefficients were determined indicating that the kinetic data conformed well to Thomas model in contrast with the report of Sivakumar and Palanisamy

(2009) but in agreement with the results obtained by Baek et al (2007). Thomas rate constant,  $K_T$  increased with increase in flow rate and initial ion concentration but remained constant at varying bed height. The maximum adsorption capacity,  $q_o$  increased with increase in flow rate and initial ion concentration but decreased with increase in bed height.

These authors used Yoon and Nelson model in the study of column adsorption kinetics (Tsai *et al.*, 1999; Kavak and Öztürk, 2004; Sivakumar and Palanisamy, 2009). The linear form of Yoon and Nelson model is represented as (Aksu and Gönen, 2004 and Sivakumar and Palanisamy, 2009).

$$\ln\left(\frac{C_e}{C_o - C_e}\right) = K_{YN}t - \tau \cdot K_{YN} \quad (2)$$

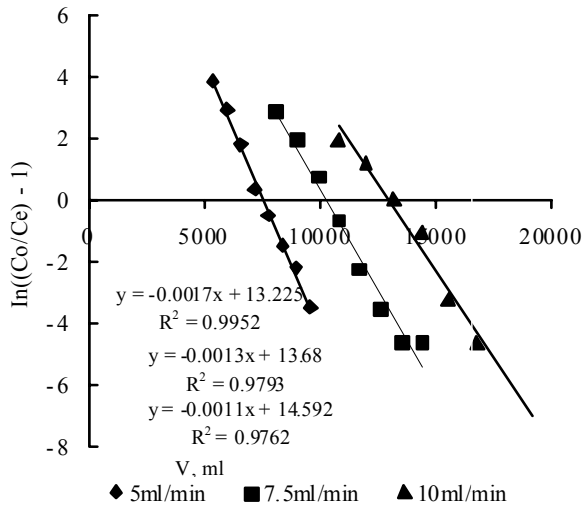

Fig. 2. Thomas kinetic plot for the adsorption of Pb<sup>2+</sup> on NPN: Effect of flow rate

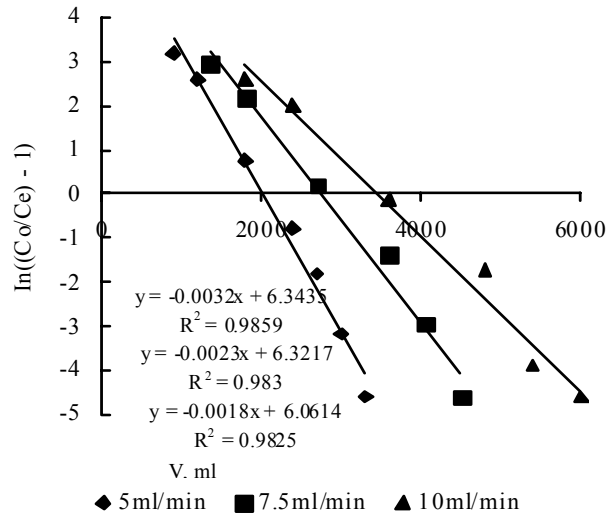

Fig. 3. Thomas kinetic plot for the adsorption of Cu<sup>2+</sup> on NPN: Effect of flow rate

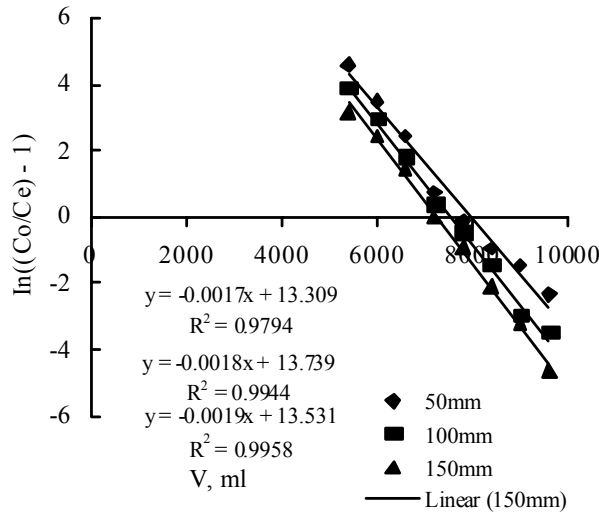

Fig. 4. Thomas kinetic plot for the adsorption of Pb<sup>2+</sup> on NPN: Effect of bed height

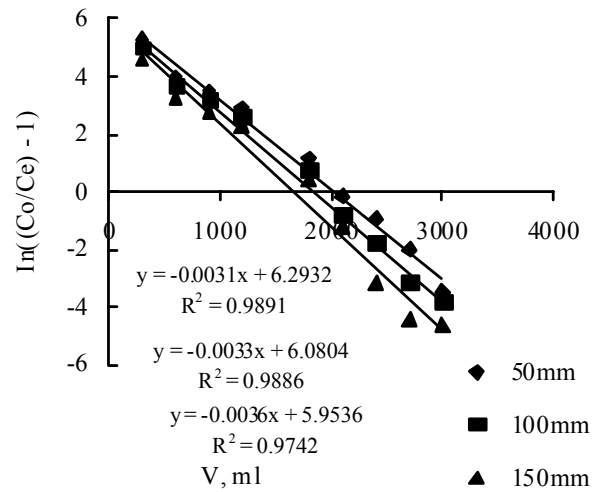

Fig. 5. Thomas kinetic plot for the adsorption of Cu<sup>2+</sup> on NPN: Effect of bed height

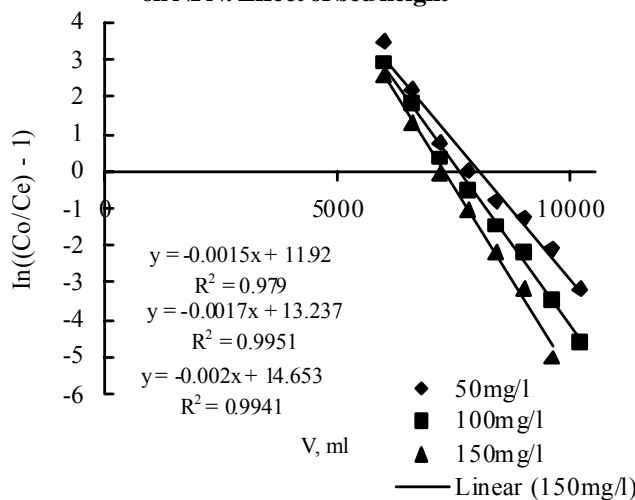

Fig. 6. Thomas kinetic plot for the adsorption of Pb<sup>2+</sup> on NPN: Effect of initial ion concentration

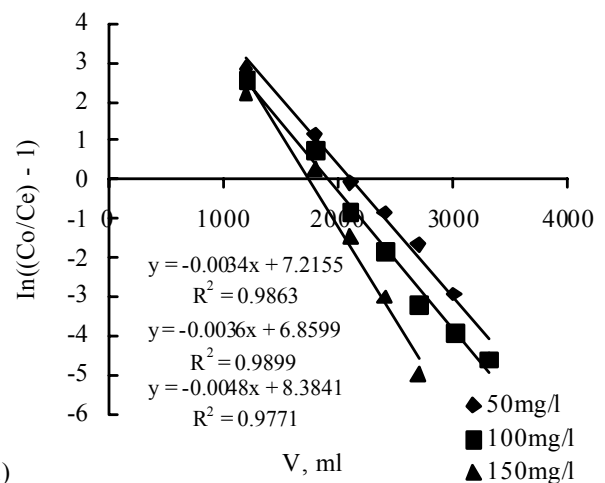

Fig. 7. Thomas kinetic plot for the adsorption of Cu<sup>2+</sup> on NPN: Effect of initial ion concentration

Where,  $K_{YN}$  is Yoon and Nelson rate constant,  $C_e$ ,  $C_0$  is the effluent and inlet solute concentrations,  $\tau$  is the time required for 50% adsorbate breakthrough (min) and  $t$  is the breakthrough (sampling) time (min).

A plot of  $\ln C_e / (C_0 - C_e)$  versus  $t$  gives a straight line with slope of  $K_{YN}$ , and intercept of  $-\tau \cdot K_{YN}$  (Figs 8, 9, 10, 11, 12, 13). The values of  $K_{YN}$ ,  $\tau$  and adsorption capacity,  $q_0$  obtained are listed in Table 2 and 3. Both  $K_{YN}$  and  $\tau$  are dependent on the initial ion concentration (Tsai *et al.*, 1999). The results show that  $K_{YN}$  increased with increased ion concentration, whereas the 50% breakthrough time,  $\tau$  decreased. Also, adsorption

capacity,  $q_0$  decreased with increase in bed height and increased with increase in flow rate and initial ion concentration. This is due to the fact that increase in initial ion concentration increases the competition between adsorbate molecules for the adsorption site, which ultimately results in increased uptake rate (Sivakumar and Palanisamy, 2009). The rate constant increased with increase in flow rate and bed height. The time required for 50% breakthrough  $\tau$  decreased with increase in flow rate and increase in initial ion concentration. High values of correlation coefficients indicate that Yoon and Nelson model fitted well to the experimental data. This is in agreement with the results obtained by Tsai, *et al.* (1999).

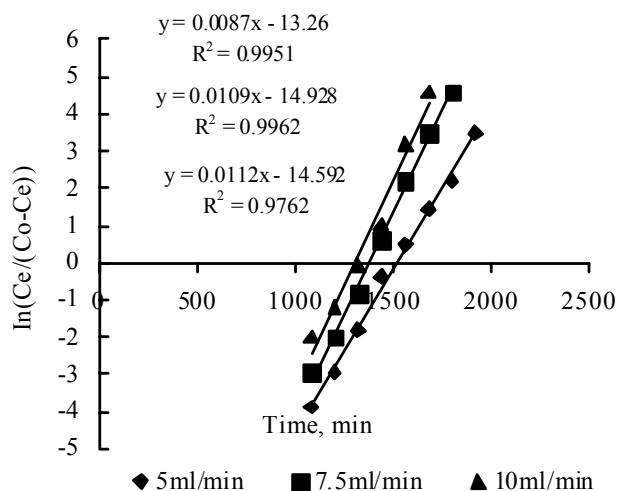

Fig. 8. Yoon and Nelson kinetic plot for the adsorption of  $Pb^{2+}$  on NPN: Effect of flow rate

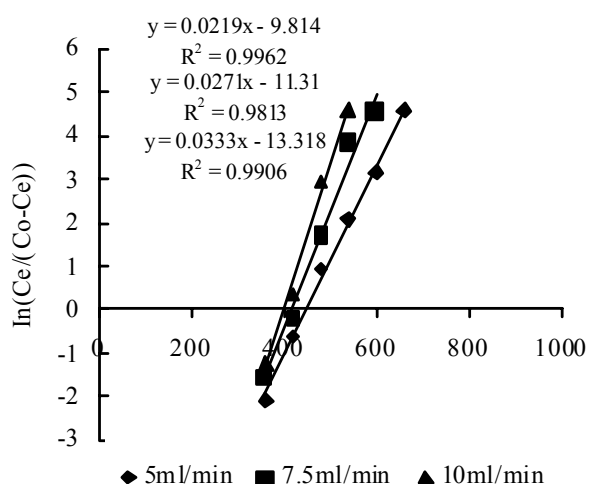

Fig. 9. Yoon and Nelson kinetic plot for the adsorption of  $Cu^{2+}$  on NPN: Effect of flow rate

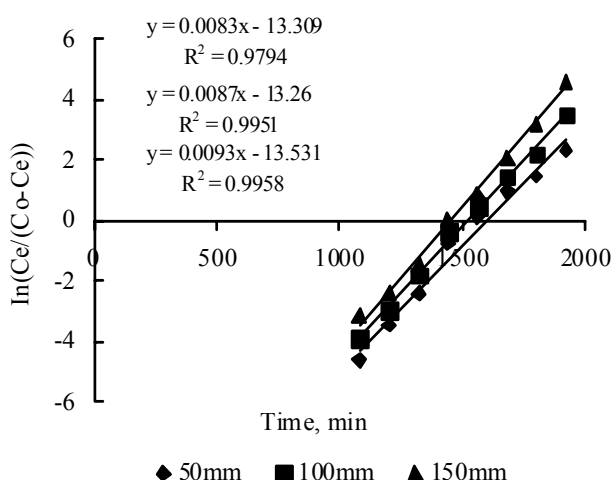

Fig.10. Yoon and Nelson kinetic plot for the adsorption of  $Pb^{2+}$  on NPN: Effect of bed height

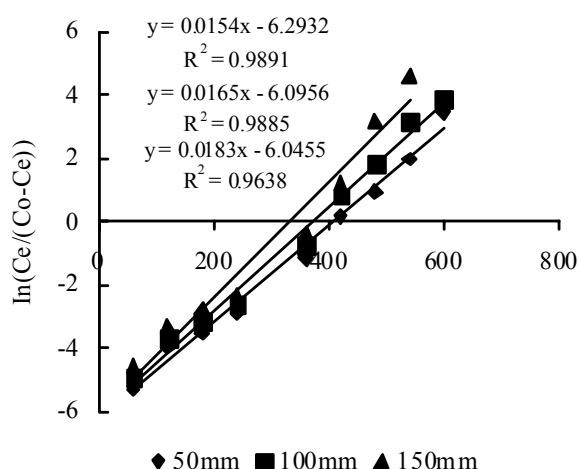
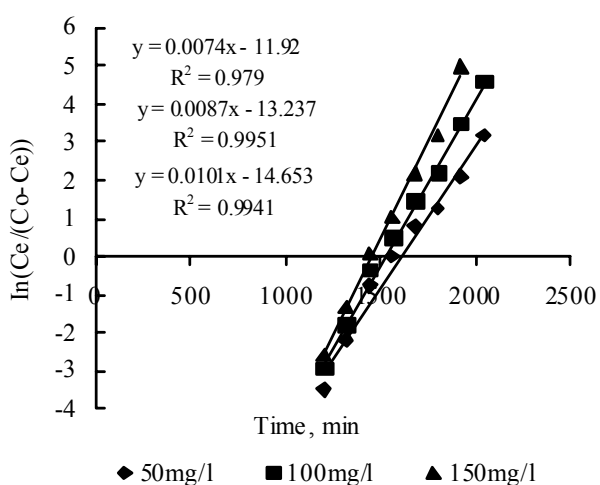
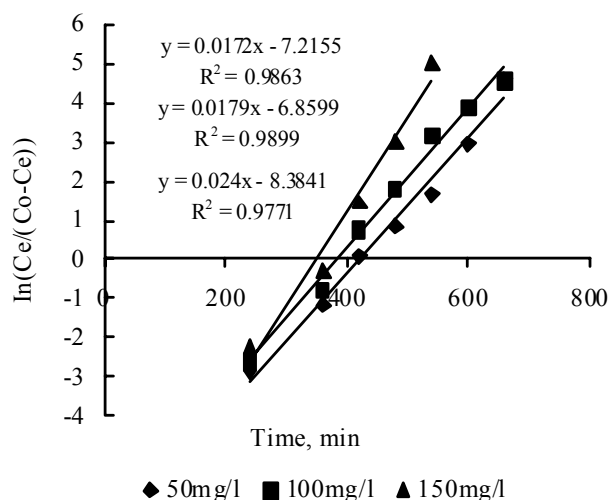

Fig.11. Yoon and Nelson kinetic plot for the adsorption of  $Cu^{2+}$  on NPN: Effect of bed height



**Fig.12. Yoon and Nelson kinetic plot for the adsorption of Pb<sup>2+</sup> on NPN: Effect of initial ion concentration**



**Fig. 13. Yoon and Nelson kinetic plot for the adsorption of Cu<sup>2+</sup> on NPN: Effect of initial ion concentration**

**Table 2. Calculated column kinetic parameters for Pb<sup>2+</sup> adsorption on NPN**

Kinetic model	Flow rate			Bed height			Initial ion conc.		
	5ml/min	7.5ml/min	10ml/min	50mm	100mm	150mm	50mg/l	100mg/l	
<b>150mg/l</b>									
<b>Thomas</b>									
K <sub>T</sub> (ml/min/mg)	0.05	0.075	0.1	0.05	0.05	0.05	0.1	0.075	0.067
q <sub>0</sub> (mg/g)	37.567	38.874	41.460	75.59	39.017	25.632	6.937	37.596	41.223
R <sup>2</sup>	0.995	0.979	0.976	0.979	0.994	0.995	0.979	0.995	0.994
<b>Yoon &amp; Nelson</b>									
K <sub>YN</sub> (min <sup>-1</sup> )	0.008	0.01	0.0011	0.008	0.008	0.008	0.007	0.008	
τ (min)	1657.5	1492	1326.4	1662.5	1657.5	1503.3	1702.9	1653.8	1465
q <sub>0</sub> (mg/g)	23.55	31.80	37.69	47.24	23.55	14.24	12.10	23.50	
R <sup>2</sup>	0.995	0.996	0.976	0.979	0.995	0.975	0.979	0.995	0.99

**Table 3. Calculated column kinetic parameters for Cu<sup>2+</sup> adsorption on NPN**

Kinetic model	Flow rate			Bed height			Initial ion conc.		
	5ml/min	7.5ml/min	10ml/min	50mm	100mm	150mm	50mg/l	100mg/l	
<b>150mg/l</b>									
<b>Thomas</b>									
K <sub>T</sub> (ml/min/mg)	0.15	0.15	0.167	0.15	0.15	0.15	0.3	0.15	
q <sub>0</sub> (mg/g)	6.008	8.981	17.224	11.922	5.789	3.759	3.417	6.497	
R <sup>2</sup>	0.985	0.983	0.982	0.989	0.988	0.974	0.986	0.989	
<b>Yoon &amp; Nelson</b>									
K <sub>YN</sub> (min <sup>-1</sup> )	0.021	0.027	0.033	0.015	0.016	0.018	0.017	0.017	
τ (min)	467.3	418.9	403.3	419.5	380.9	335.8	424.4	403.5	
q <sub>0</sub> (mg/g)	6.64	8.92	11.46	11.92	5.41	3.18	3.02	5.73	7.44
R <sup>2</sup>	0.996	0.981	0.990	0.989	0.988	0.963	0.986	0.989	

To evaluate the adsorption performance of an adsorbent, the mathematical model for the simulation of adsorption processes to predict the adsorption behaviour is needed (Xiang *et al.*, 2008). Yoon and Nelson model was chosen to fit the experimental data. Figs 14 and 15 present the experimental breakthrough curves obtained for each activated carbon at flow rate

of 5ml/min, inlet ion concentration of 100mg/l and bed height of 100mm. The theoretical curves calculated according to the proposed model are also shown in Figs 14 and 15. It can be seen that the theoretical curve is in good agreement with those of the experimental curve. This is in agreement with the results obtained by Kavak and Öztürk (2004) and Sivakumar and Palanisamy (2009).

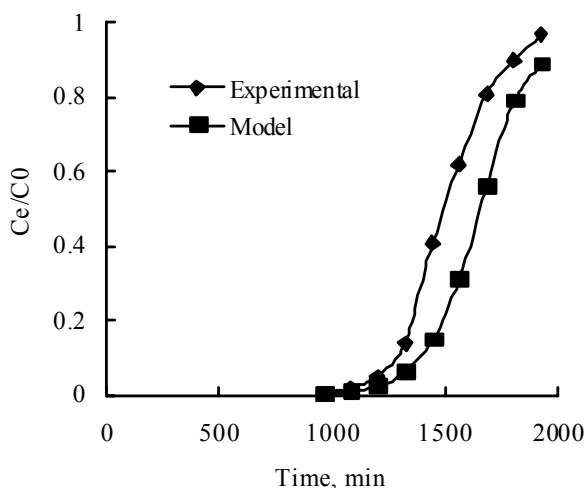

Fig. 14. Comparison of experimental and predicted curves for the adsorption of  $Pb^{2+}$  on NPN

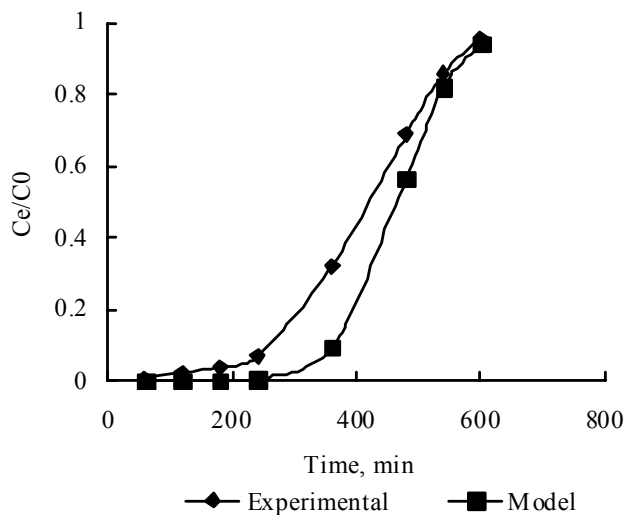

Fig. 15. Comparison of experimental and predicted curves for the adsorption of  $Cu^{2+}$  on NPN

## CONCLUSION

The adsorptive removal of lead(II) and copper(II) from aqueous solution in a fixed bed column using activated carbon prepared from nipa palm nut has been investigated. Thomas and Yoon and Nelson kinetic models were used to describe the column adsorption kinetics. The experimental data fitted the kinetic models. The rate constants, adsorption capacity, and time for 50% adsorbate breakthrough were dependent on flow rate, bed height and initial ion concentration. The experimental breakthrough curve compared satisfactorily with the breakthrough profile calculated by Yoon and Nelson method. The determined column parameters can be scaled up for the design of fixed bed columns.

## REFERENCES

Ahmad, A. A., Hameed, B. H. and Aziz, N. (2006). Adsorption of direct dye on palm ash: kinetic and equilibrium modeling. *Journal of Hazardous Materials*, **94**, 1-10.

Ahmedna, M., Johns, M. M., Clarke, S. J., Marshall, W. E. and Rao, R. M. (1997). Potential of agricultural by-product-based activated carbons for use in raw sugar decolourisation. *Journal of the Science of Food and Agriculture*, **75**, 117-124.

Alimohammad Kalhori, A., Jafari, H. R., Yavari, A. R., Prohiae, E. and Ahmadzadeh Kokya, T. (2012). Evaluation of Anthropogenic Impacts on Soil and Regolith Materials Based on BCR Sequential Extraction Analysis. *Int. J. Environ. Res.*, **6** (1), 185-194.

Al-Qodah, Z. and Shawabkha, R. (2009). Production and characterization of granular activated carbon from activated sludge. *Braz. J. Chem. Eng.*, **26** (1), 6.

Alzaydian, A. S. (2009). Adsorption of methylene blue from aqueous solution onto a low-cost natural Jordanian Tripoli. *Am. J. Applied Sci.*, **6** (6), 1047-1058.

Ashraf, M. A., Maah, M. J. and Yusoff, I. (2012). Bioaccumulation of Heavy Metals in Fish Species Collected From Former Tin Mining Catchment. *Int. J. Environ. Res.*, **6** (1), 209-218.

ASTM, (1996). American Society for Testing and Materials, Annual Book of ASTM Standard, Volume 15.01, Refractories, Carbon and Graphic Products; activated Carbon, ASTM, Philadelphia, PA.

ASTM, (1986). American Society for Testing and Materials, Standard test method for determination of iodine number of activated carbon. Philadelphia, PA: ASTM Committee on Standards.

ASTM, (1991). American Society of Testing and Materials, Standard test methods for moisture in activated carbon. Philadelphia, PA: ASTM Committee on Standards.

- Antonijevic, M. M. and Petrovic, M. B. (2008). Copper corrosion inhibitors: a review. *Int. J. of Electrochemical Science*, **3**, 1-28.
- Back, K., Song, S., Kang, S., Rhee, Y., Lee, C., Lee, B., Hudson, S. and Hwang, T. (2007). Adsorption kinetics of boron by anion exchange resin in packed column bed. *J. Ind. Eng. Chem.*, **13** (3), 452-456.
- Bansal, R. C. and Goyal, M. (2005). *Activated Carbon Adsorption*. USA: CRC Press, 1st ed., 1-5.
- Diviš, P., Machát, J., Szkandera, R. and Doëekalová, H. (2012). In situ Measurement of Bioavailable Metal Concentrations at the Downstream on the Morava River using Transplanted Aquatic mosses and DGT Technique. *Int. J. Environ. Res.*, **6** (1), 87-94.
- Ghaderi, A. A., Abdul, M. A., Karbassi, A. R., Nasrabadi, T. and Khajeh, M. (2012). Evaluating the Effects of Fertilizers on Bioavailable Metallic Pollution of soils, Case study of Sistan farms, Iran. *Int. J. Environ. Res.*, **6** (2), 565-570.
- Gupta, V. K. (2003). Removal of cadmium and nickel from wastewater using bagasse fly ash – a sugar industry waste. *Water Res.*, **37** (16), 4038.
- Gupta, V. K. and Ali, I. (2004). Removal of lead and chromium from wastewater using bagasse fly ash-sugar industry waste. *J. Colloid Interface Sci.*, **271** (2), 321-328.
- Haruna, A. Uzairu, A. and Harrison, G.F.S. (2011). Chemical Fractionation of Trace Metals in Sewage Water – Irrigated Soils. *Int. J. Environ. Res.*, **5** (3), 733-744.
- Kavak, D. and Öztürk, N. (2004). Adsorption of boron from aqueous solution by sepiolite: II. Column studies. II. *Illuslrarasi. Bor. Sempozyumu*, **23-25**, 495-500.
- Kargar, M., Khorasani, N. A., Karami, M., Rafiee, G. H. and Naseh, R. (2012). An Investigation on As, Cd, Mo and Cu Contents of Soils Surrounding the Meyduk Tailings Dam. *Int. J. Environ. Res.*, **6** (1), 173-184.
- Markovska, L. T., Meshko, V. D. and Marinkovski, M. S. (2006). Modelling of the adsorption kinetics of zinc onto granular activated carbon and natural zeolite. *J. Serb. Chem. Soc.*, **71** (8-9), 957-967.
- Maximova, A. and Koumanova, B. (2008). Equilibrium and kinetics study of adsorption basic dyes onto perfil from aqueous solution. *J. Univ. Chem. Technol. Met.*, **43** (1), 101-108.
- Mhadhbi, L., Palanca, A., Gharred, T., and Boumaiza, M. (2012). Bioaccumulation of Metals in Tissues of Solea Vulgaris from the outer Coast and Ria de Vigo, NE Atlantic (Spain). *Int. J. Environ. Res.*, **6** (1), 19-24.
- Mineceva, M., Taparcevska, J., Markouska, L., Koumanova, B. and Meshko, V. (2008). Adsorption kinetics of Pb<sup>2+</sup> onto natural zeolite. *Journal of the University of Chem. Tech. And Metallurgy*, **43** (1), 93-100.
- Mohan, S. V., Rao, N. C. and Karthikeyan, J. (2002). Adsorption removal of direct azo dye from aqueous phase onto coal based sorbents: a kinetic and mechanistic study. *J. Hazard. Mater.*, **90**, 189-204.
- Mzoughi, N. and Chouba, L. (2012). Heavy Metals and PAH Assessment Based on Mussel Caging in the North Coast of Tunisia (Mediterranean Sea). *Int. J. Environ. Res.*, **6** (1), 109-118.
- Nasrabadi T., Nabi Bidhendi G. R., Karbassi A. R., Mehrdadi N. (2010). Evaluating the efficiency of sediment metal pollution indices in interpreting the pollution of Haraz River sediments, southern Caspian Sea basin. *Environmental monitoring and assessment*, **171** (1-4), 395-410.
- Nollet, H., Roels, M., Lutgen, P., Meeren, P. V. and Verstraete, W. (2003). Removal of PCB<sub>s</sub> from wastewater using fly ash. *Chemosphere*, **53**, 655-665.
- Ogundiran, M. B., Ogundele, D. T., Afolayan, P. G. and Osibanjo, O. (2012). Heavy Metals Levels in Forage Grasses, Leachate and Lactating Cows Reared around Lead Slag Dumpsites in Nigeria. *Int. J. Environ. Res.*, **6** (3), 695-702.
- Okuku, E.O. and Peter, H. K. (2012). Choose of Heavy Metals Pollution Biomonitors: A Critic of the Method that uses Sediments total Metals Concentration as the Benchmark. *Int. J. Environ. Res.*, **6** (1), 313-322.
- Ong, S., Seng, C. and Lim, P. (2007). Kinetics of adsorption of Cu (II) and Cd (II) from aqueous solution on husk and modified rice husk. *EJEAfche*, **6** (2), 1764-1774.
- Ozacar, M. (2003). Equilibrium and kinetic modelling of adsorption of phosphorous on calcined alunite. *Adsorption*, **9**, 125-132.
- Qaiser, S., Saleem, A. R. and Ahmed, M. M. (2007). Heavy metal uptake by agro based waste materials. *Environmental Biotechnol.*, **10** (3), 1-8.
- Ricou, P. Lecuyer, I. and Cloirec, P. L. (2001). Experimental design methodology applied to adsorption of metallic ions onto fly ash, *Water Res.*, **35** (4), 965.
- Roque-Marlberbe, R. M. A. (2007). *Adsorption and Diffusion in Nonporous Materials*. USA: CRS Press, 39-255.
- Serbaji, M. M., Azri, C. and Medhioub, K. (2012). Anthropogenic Contributions to Heavy Metal Distributions in the Surface and Sub-surface Sediments of the Northern Coast of Sfax, Tunisia. *Int. J. Environ. Res.*, **6** (3), 613-626.
- Sivakumar, P. and Palanisamy, P. N. (2009). Adsorption studies of basic Red 29 by a non-conventional activated carbon prepared from *Euphorbia antiquorum* L. *International Journal of Chem. Tec. Research*, **1** (3), 502-510.
- Tsai, W. T., Chang, C. Y., Ho, C. Y. and Chen, L. Y. (1999). Simplified description of adsorption breakthrough curves of 1, 1-dichloro-1-fluoroethane (HCFC – 141b) on activated carbon with temperature effect. *Journal of Colloid and Interface Science*, **214**, 455-458.
- Volesky, B. and Holan, Z. R. (1995). Biosorption of heavy metals. *Biotechnology Progress*, **11** (3), 235-250.
- Yu, Ch., Xu, Sh., Gang, M., Chen, G. and Zhou, L. (2011). Molybdenum pollution and speciation in Nver River sediments impacted with Mo mining activities in western Liaoning, northeast China. *Int. J. Environ. Res.*, **5** (1), 205-212.